



SPECIFICATIONS

9635

INDUSTRIAL FANS

**30" Oscillating
I-Beam Mount Fan**

- **Motor**
3-speed, 1/4 HP, 120V, 1 phase, totally enclosed, ball bearing, permanently lubricated, permanent split capacitor
- **Controls**
Rear mounted pull cord switch
- **Power Cord**
Black, 10', 3-conductor, SJT type
- **Coating**
Blade, Guard, and Mounts are powder coated steel
- **Compliance**
ETL, OSHA
- **Oscillation**
90°
- **Shipping Information**
UPC: 0-46013-38760-8
Shipping Weight: 79.9 lbs.
- **Product Dimensions**
42"L x 33"W x 44"H

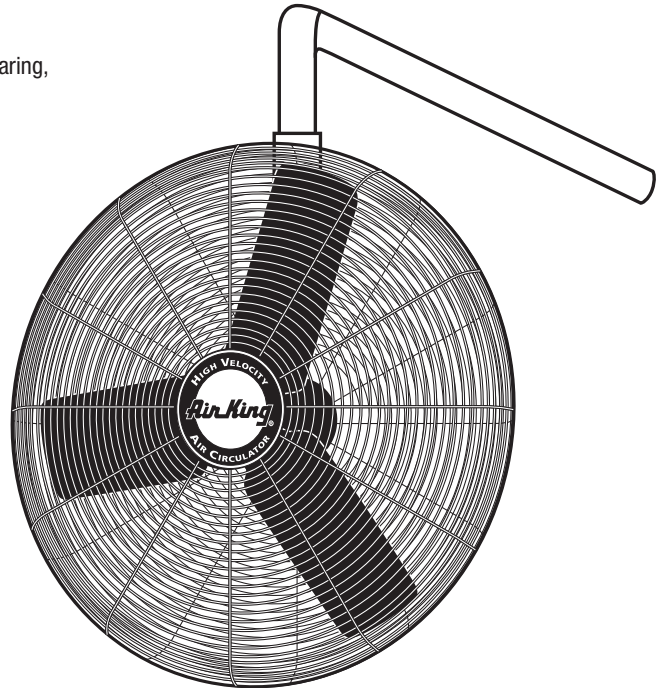

MODEL	CFM			RPM			AMPS			WATTS			DB A		
	HIGH	MED	LOW	HIGH	MED	LOW	HIGH	MED	LOW	HIGH	MED	LOW	HIGH	MED	LOW
9635	7400	6360	4980	1040	902	860	2.4	1.9	1.5	255	200	154	75	71	67



U.S.: 820 Lincoln Drive
West Chester, Pennsylvania 19380-4466
Tel: (610) 692-7400 • 877-304-3785
Fax: (610) 696-8048