



SPECIFICATIONS

9674

INDUSTRIAL FANS

**24" Oscillating
I-Beam Mount Fan**

- **Motor**
3-speed, 1/3 HP, 120V, 1 phase, totally enclosed, ball bearing, permanently lubricated, permanent split capacitor
- **Controls**
Rear mounted pull cord switch
- **Power Cord**
Black, 10', 3-conductor, SJT type
- **Coating**
Blade, Guard, and Mounts are powder coated steel
- **Compliance**
ETL, OSHA
- **Oscillation**
90°
- **Shipping Information**
UPC: 0-46013-38850-6
Shipping Weight: 74.2 lbs.
- **Product Dimensions**
41"L x 27"W x 41"H

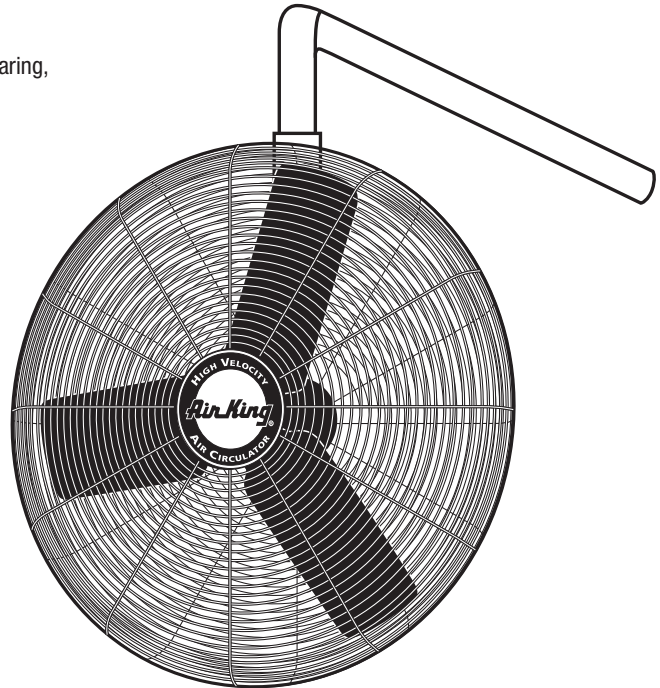

MODEL	CFM			RPM			AMPS			WATTS			DB A		
	HIGH	MED	LOW	HIGH	MED	LOW	HIGH	MED	LOW	HIGH	MED	LOW	HIGH	MED	LOW
9674	5770	5250	4270	1054	869	673	2.5	2.0	1.4	332	226	152	69	67	59



U.S.: 820 Lincoln Drive
West Chester, Pennsylvania 19380-4466
Tel: (610) 692-7400 • 877-304-3785
Fax: (610) 696-8048