

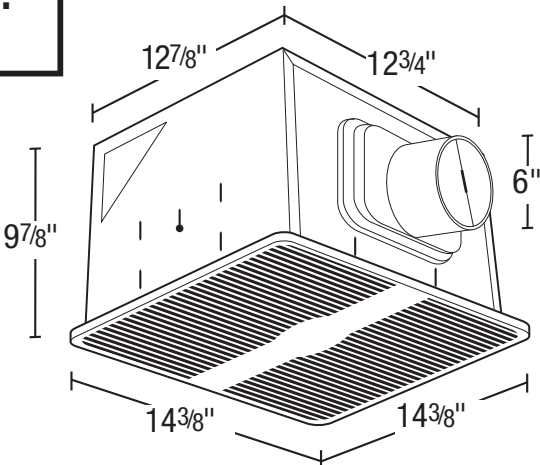

SPECIFICATIONS
AK150LS
 EXHAUST FANS

2100 HVI CERTIFIED **150 CFM/0.8 Sones @ 0.10" SP.**
116 CFM @ 0.25 SP.



- **Grill**
White, polymeric grill secured in place with torsion springs; easily removed if necessary, dimensions - 14³/₈" x 14³/₈".
- **Blower Wheel**
Balanced polymeric dual inlet blower wheel 6" dia. x 5³/₈" depth, 59 paddles, secured in place using 8M hex nut.
- **Motor**
Enclosed 4 pole electronically balanced permanently split capacitor motor (PSC); life time lubrication, suitable for continuous operation. Motor bearings - ball. Rated 115/120 volts, 60 Hz.
- **Fan Housing**
23 gauge galvanized steel housing.
Overall dimensions 127⁷/₈"x 12³/₄"x 97⁷/₈".
- **Duct Collar**
6" round, zinc plated metal collar adapter. 6" spring loaded aluminum backdraft damper.
- **Ventilating Area**
For bathrooms up to 150 sq. ft. For other rooms up to 185 sq. ft.
- **Electrical Connections**
1/2" electrical knockouts provided. Easy wiring access via either internal or external wiring compartment cover.
- **Single Pack Shipping Info**
Box Dim: 20" x 15⁷/₈" x 11³/₈"
UPC: 0-8316221502-4
Shipping Weight: 17 lbs.

Acceptable for use over tub or shower when installed in a GFCI protected branch circuit.



- **Unit Mounting**
The housing will mount in ceilings with at least 10" of clearance and through drywall thickness up to 3/4", with a rough-in opening of 13¹/₈" x 13". The housing will mount either between 16" or 24" on center joists, using the 4 supplied housing mounting rails. The housing mounting rails can be adapted for overhead mounting (hardware not provided).

EXPANDED PERFORMANCE											
	Static Pressure (inches of w.g.)							Sones @ .1 SP	Fan Speed RPM	Maximum Fan Watts	Amps
	0	0.05	0.1	0.15	0.2	0.25	0.375				
Air Flow - CFM	169	159	150	140	129	116	76	0.8	845	37.0	0.3

PROJECT							ARCHITECT				
LOCATION							ENGINEER				
CONTRACTOR							SUBMITTED BY			DATE	
FAN NUMBER	MODEL NUMBER	CFM	IN W.G.	RPM	WATTS	AMPS	SONES	QTY	OPTIONAL EQUIPMENT & REMARKS		



U.S.: 820 Lincoln Avenue
 West Chester, Pennsylvania 19380-4466
 Tel: (610) 692-7400 • 877-304-3785
 Fax: (610) 696-8048

Canada:
 Brampton, Ontario
 Tel: 800-250-8767
 Fax: (905) 456-1015