

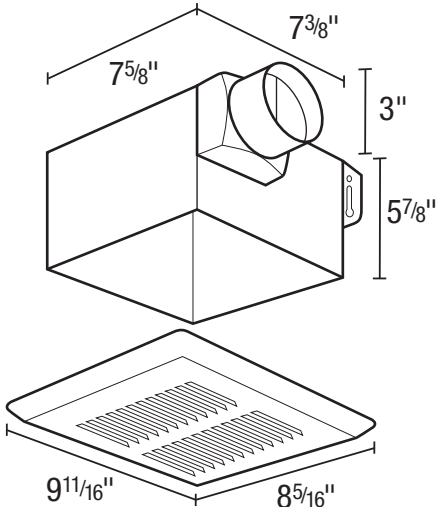

SPECIFICATIONS  
**FRAS70**  
 EXHAUST FAN

**70 CFM/4.0 Sones @ 0.10" SP.**



- **Grill**  
Cold rolled steel, powder coated white.
- **Blower Wheel**  
One piece polymeric wheel, 4.5" diameter, 1" wide, with 10 fins.
- **Motor**  
Single coil plug-in, two pole motor, life time lubrication, thermally protected. Rated 120 volts, 60 hz.  
**Contractor Pack (Motor/BladeGrill) Model: FA70T\***
- **Fan Housing**  
24 gauge galvanized steel housing, dimensions 7<sup>3</sup>/<sub>8</sub>" x 7<sup>5</sup>/<sub>8</sub>" x 5<sup>7</sup>/<sub>8</sub>".  
**Contractor Pack Model: AKFH1\***
- **Duct Collar**  
Metal collar for 3" duct connection, comes complete with built in back draft damper.
- **Ventilating Area**  
For rooms up to 85 sq. ft.
- **Unit Mounting**  
FRAS70 is centered between joists (with 16" centers) using hanging brackets. The housing will mount through drywall thickness up to 3/4", with a rough-in opening of 7<sup>3</sup>/<sub>8</sub>" x 7<sup>5</sup>/<sub>8</sub>".

\* Sold in packs of 4. All three parts (housing, damper, motor/blade/grill) must be purchased and used together to make a complete unit.

Acceptable for use over tub or shower when installed in a GFCI protected branch circuit.

- **Damper**  
**Blanket** - Non-asbestos, ceramic blanket  
**Fusible Link** - Replaceable, 165°F standard  
**Classification** - CUL Listed 555C and 263. California State Marshall classification for 3 hour fire damper rating. California State Marshall listing number 3226-1721:0109.  
**Contractor Pack Model: AKFD1\***
- **Truss Designs**  
L501, L502, L503, L506, L507, L508, L512, L513, L514, L515, L516, L517, L519, L522, L523, L533, L537, L545, L581, L583

EXPANDED PERFORMANCE											
	Static Pressure (inches of w.g.)							Sones @ .1 SP	Fan Speed RPM	Power Watts	Amps
	0	0.05	0.1	0.125	0.15	0.2	0.25				
<b>Air Flow - CFM</b>	75	70	70	67	65	62	59	4.0	2175	50.0	0.9

<b>PROJECT</b>							<b>ARCHITECT</b>				
<b>LOCATION</b>							<b>ENGINEER</b>				
<b>CONTRACTOR</b>							<b>SUBMITTED BY</b>			<b>DATE</b>	
FAN NUMBER	MODEL NUMBER	CFM	IN W.G.	RPM	WATTS	AMPS	SONES	QTY	OPTIONAL EQUIPMENT & REMARKS		

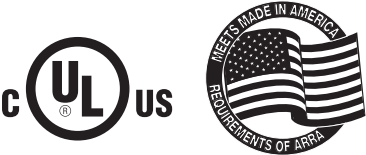

**U.S.:** 820 Lincoln Avenue  
 West Chester, Pennsylvania 19380-4466  
 Tel: (610) 692-7400 • 877-304-3785  
 Fax: (610) 696-8048

**Canada:**  
 Brampton, Ontario  
 Tel: 905-456-2033  
 Fax: (905) 456-1015