



SPECIFICATIONS

9035

INDUSTRIAL FANS

**30" Oscillating
Wall Mount Fan**

- **Motor**
3-speed, 1/4 HP, 120V, 1 phase, totally enclosed, ball bearing, permanently lubricated, permanent split capacitor
- **Controls**
Rear mounted pull cord switch
- **Power Cord**
Black, 10', 3-conductor, S type
- **Coating**
Blade, Guard, and Mounts are powder coated steel
- **Compliance**
ETL, OSHA
- **Oscillation**
90°
- **Product Dimensions**
33.75"L x 25.75"W x 38.75"H
- **Shipping Information**
UPC: 0-46013-39550-4
Shipping Weight: 46.6 lbs.

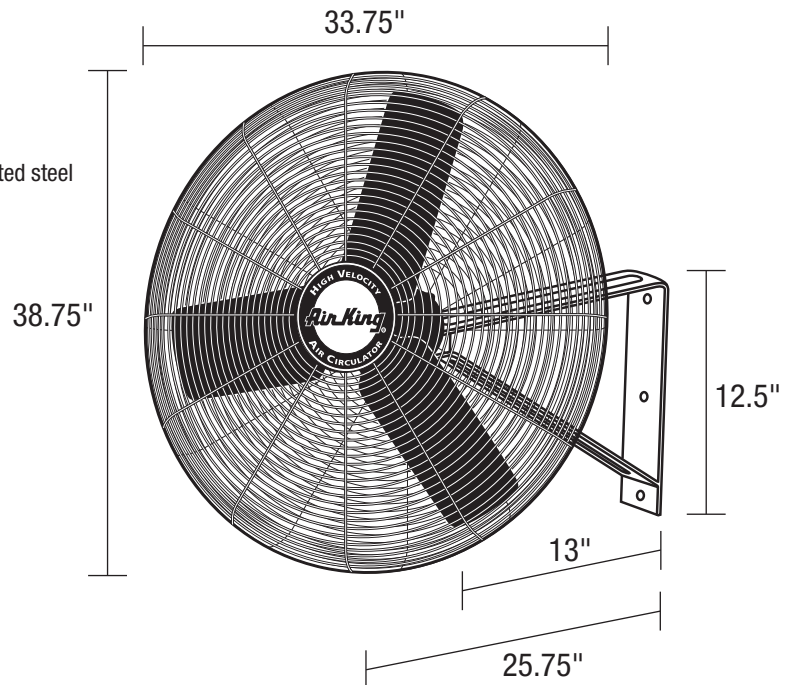

MODEL	CFM			RPM			AMPS			WATTS			DB A		
	HIGH	MED	LOW	HIGH	MED	LOW	HIGH	MED	LOW	HIGH	MED	LOW	HIGH	MED	LOW
9035	7400	6360	4980	1040	902	860	2.4	1.9	1.5	255	200	154	75	71	67



U.S.: 820 Lincoln Drive
West Chester, Pennsylvania 19380-4466
Tel: (610) 692-7400 • 877-304-3785
Fax: (610) 696-8048