



SPECIFICATIONS

9670

INDUSTRIAL FANS

30" I-Beam Mount Fan

- **Motor**
3-speed, 1/3 HP, 120V, 1 phase, totally enclosed, ball bearing, permanently lubricated, permanent split capacitor
- **Controls**
Rear mounted pull cord switch
- **Power Cord**
Black, 10', 3-conductor, S type
- **Coating**
Blade, Guard, and Mounts are powder coated steel
- **Compliance**
ETL, OSHA
- **Product Dimensions**
42"L x 33"W x 44"H
- **Shipping Information**
UPC: 0-46013-38860-5
Shipping Weight: 77.3 lbs.

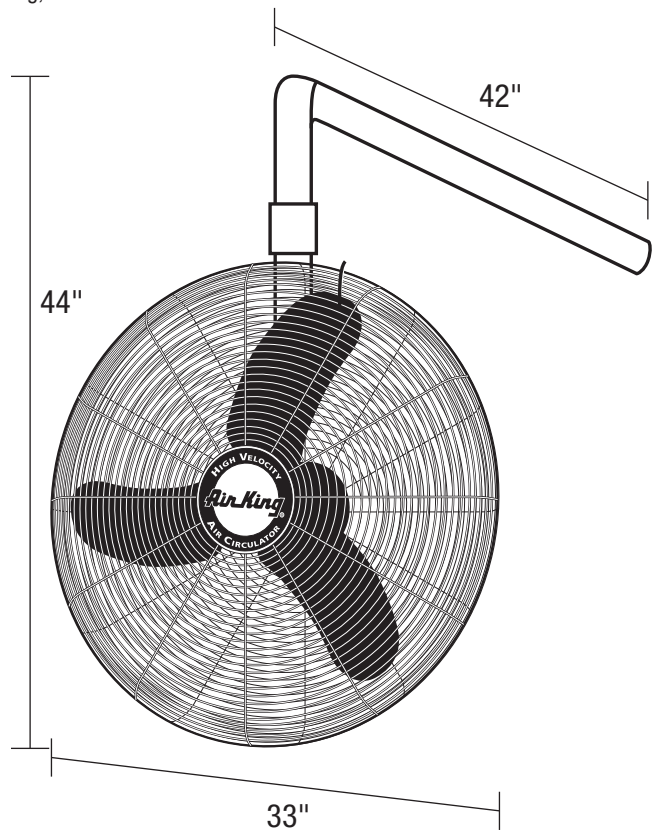

MODEL	CFM			RPM			AMPS			WATTS			DB A		
	HIGH	MED	LOW	HIGH	MED	LOW	HIGH	MED	LOW	HIGH	MED	LOW	HIGH	MED	LOW
9670	8780	7480	5570	1075	925	800	2.8	2.0	1.7	308	205	170	72	70	64



U.S.: 820 Lincoln Drive
West Chester, Pennsylvania 19380-4466
Tel: (610) 692-7400 • 877-304-3785
Fax: (610) 696-8048