



SPECIFICATIONS

AS70

EXHAUST FAN



70 CFM/5.5 Sones @ 0.10" SP.

• **Grill**

White, polymeric grill secured in place with torsion springs; easily removed if necessary, dimensions - 10" x 9 1/2".

• **Blower Wheel**

One piece polymeric wheel, 4 1/2" diameter, 1" wide, with 10 fins.

• **Motor**

Single coil plug-in, two pole motor, life time lubrication, thermally protected. Rated 120 volts, 60 hz. Rated for continuous use.

• **Fan Housing**

23 gauge galvanized metal housing, dimensions 7 1/4" x 7 1/4" x 3 3/4", double metal thickness mounting tabs.

• **Duct Collar**

Plastic collar for 3" duct connection, comes complete with built in non-metallic back draft damper for quiet operation.

• **Ventilating Area**

For bathrooms up to 70 sq. ft. for other rooms up to 85 sq. ft.

• **Unit Mounting**

Designed to mount in ceilings or walls with at least 4" of clearance. The housing will mount through drywall thickness up to 3/4", with a rough-in opening of 7 1/2" x 7 1/2".

• **Single Pack Shipping Info**

Box Dim: 11" x 10 3/8" x 4 3/4"

UPC: 0-8316227311-6

Shipping Weight: 3.6 lbs.

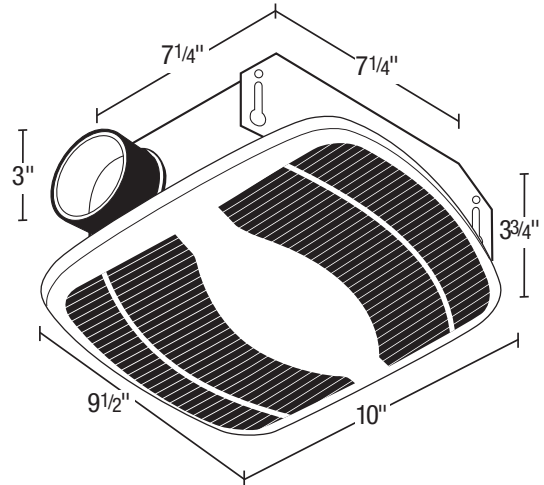

Acceptable for use over tub or shower when installed in a GFCI protected branch circuit.

EXPANDED PERFORMANCE

	Static Pressure (inches of w.g.)							Sones @ .1 SP	Fan Speed RPM	Maximum Fan Watts	Amps
	0	0.1	0.125	0.15	0.2	0.25	0.3				
Air Flow - CFM	75	70	69	67	65	62	59	5.5	2175	50	0.9

PROJECT							ARCHITECT				
LOCATION							ENGINEER				
CONTRACTOR							SUBMITTED BY			DATE	
FAN NUMBER	MODEL NUMBER	CFM	IN W.G.	RPM	WATTS	AMPS	SONES	QTY	OPTIONAL EQUIPMENT & REMARKS		



U.S.: 820 Lincoln Avenue
West Chester, Pennsylvania 19380-4466
Tel: (610) 692-7400 • 877-304-3785
Fax: (610) 696-8048

Canada:
Brampton, Ontario
Tel: 905-456-2033
Fax: (905) 456-1015