

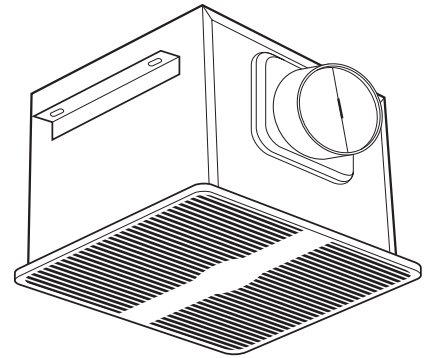

SPECIFICATIONS
AKA200
 EXHAUST FAN

210 CFM/1.4 Sones @ 0.10" SP.
199 CFM @ 0.25" SP.

- **Grill**
 White, polymeric grill secured in place with torsion springs; easily removed if necessary, dimensions - 14 1/4" x 14 1/4".
- **Blower Wheel**
 Balanced polymeric dual inlet blower wheel secured in place using a hex nut.
- **Motor**
 Enclosed 4 pole high efficiency, permanently split capacitor motor (PSC); life time lubrication, suitable for continuous operation. Motor bearings - sleeve. Rated 115/120 volts, 60 Hz.
- **Fan Housing**
 23 gauge galvanized steel housing with 1" thermal & acoustical insulation. Overall dimensions: 12 11/16"W x 13 1/16"D x 12 9/16"H.
- **Duct Collar**
 6" round, zinc plated metal collar adapter. Gasketed, spring loaded aluminum backdraft damper.
- **Electrical Connections**
 0.5" electrical knockouts provided. Easy wiring access via either internal or external wiring compartment cover.
- **Single Pack Shipping Info**
 Shipping Weight: 17 lbs.



- **Unit Mounting**
 2 supplied housing mounting angles. The housing mounting angles can be adapted for inline or top discharge mounting (hardware not provided).

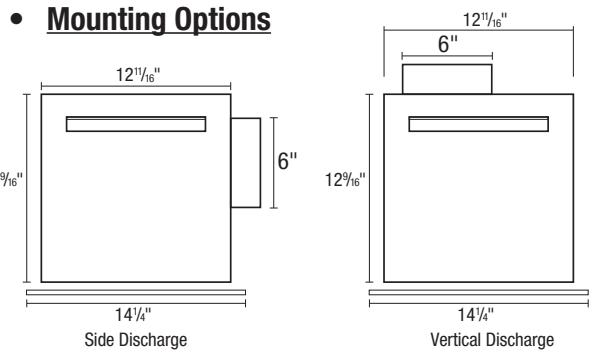

EXPANDED PERFORMANCE											
	Static Pressure (inches of w.g.)							Sones @ 0.1 SP	Fan Speed RPM	Maximum Fan Watts	Amps
	0	0.1	0.125	0.2	0.25	0.375	0.5				
Air Flow - CFM	218	210	209	203	199	180	147	1.4	987	59.0	0.5

PROJECT							ARCHITECT				
LOCATION							ENGINEER				
CONTRACTOR							SUBMITTED BY			DATE	
FAN NUMBER	MODEL NUMBER	CFM	IN W.G.	RPM	WATTS	AMPS	SONES	QTY	OPTIONAL EQUIPMENT & REMARKS		



Air King: 820 Lincoln Avenue
 West Chester, Pennsylvania 19380-4466
 Tel: (610) 692-7400 • 877-304-3785
 Fax: (610) 696-8048

Canada:
 Brampton, Ontario
 Tel: 905-456-2033
 Fax: (905) 456-1015